

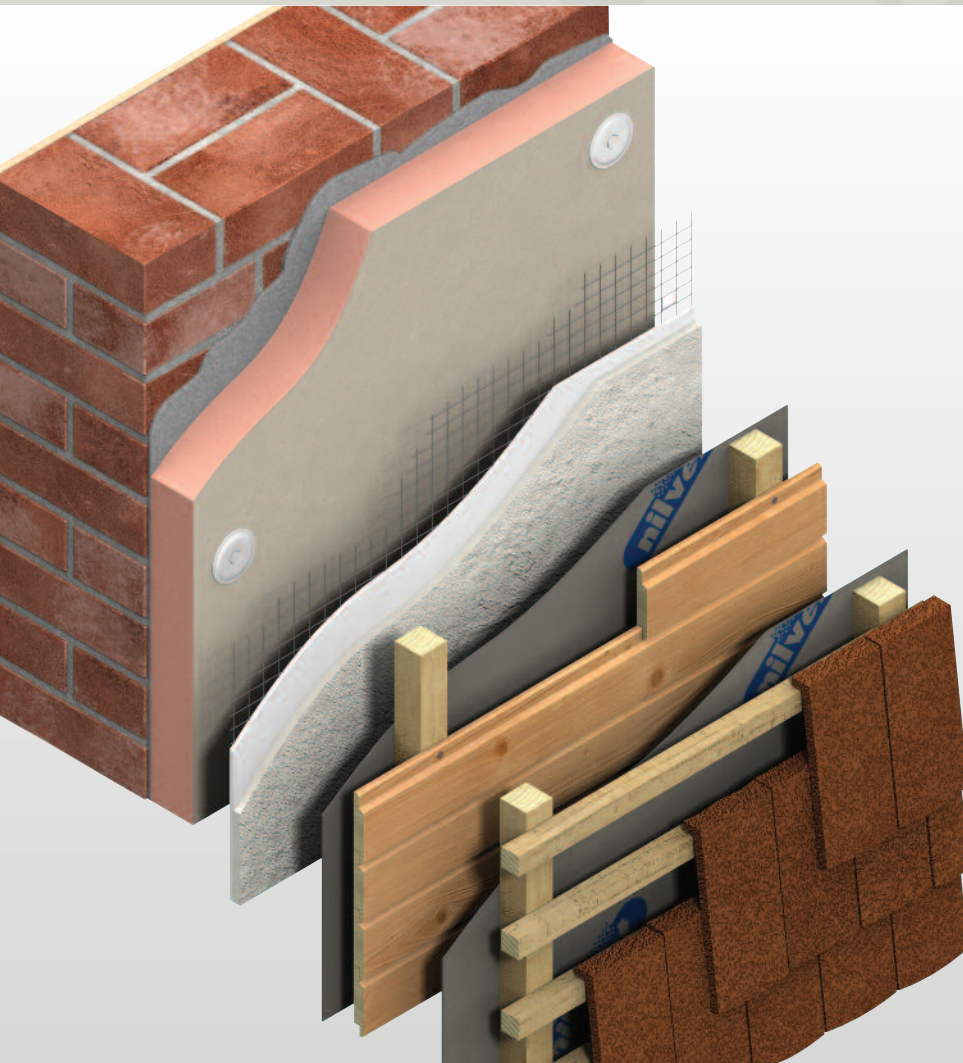

# Kooltherm® K5 External Wall Board

EXTERNAL INSULATION FOR MASONRY WALLS



- Premium performance rigid thermoset insulation – thermal conductivities as low as 0.020 W/m-K
- Class 0 fire rating
- Class 0 fire rated insulation core
- Negligible smoke obscuration
- Suitable for use behind traditional and lightweight polymer modified renders and dry cladding systems
- Unaffected by air infiltration
- Resistant to the passage of water vapour
- Easy to handle and install
- Ideal for new build and refurbishment
- Non-deleterious material
- Manufactured with a blowing agent that has zero ODP and low GWP



*Low Energy –  
Low Carbon Buildings*

# Typical Constructions and U-values

## Assumptions

The U-values in the tables that follow have been calculated, under a management system certified to the BBA Scheme for Assessing the Competency of Persons to Undertake U-value and Condensation Risk Calculations, using the method detailed in BS / I.S. EN ISO 6946: 2007 (Building components and building elements. Thermal resistance and thermal transmittance. Calculation method), and using the conventions set out in BR443 (Conventions for U-value calculations). They are valid for the constructions shown in the details immediately above each table.



For the refurbishment examples, the internal wall finish is taken as 13 mm dense plaster unless stated otherwise. For the new build examples, the internal wall finish is taken to be a 3 mm skim coated 12.5 mm plasterboard on dabs, unless stated otherwise. In all examples, where the external wall finish is rendered, this is taken to be a 10 mm polymer render.

*NB When calculating U-values to BS / I.S. EN ISO 6946: 2007, the type of mechanical fixing used may change the thickness of insulation required. These calculations assume telescopic tube fasteners with a thermal conductivity of 1.00 W/m·K or less, the effect of which is insignificant. For the 'Ventilated Cladding' options the use of carbon steel fasteners of cross sectional area of 7.44 mm<sup>2</sup> has been assumed at a density of 4.4 per m<sup>2</sup>.*

*NB For the purposes of these calculations the standard of workmanship has been assumed good, and therefore the correction factor for air gaps has been ignored.*

*NB The figures below are for guidance only. A detailed U-value calculation and a condensation risk analysis should be completed for each project.*

*NB If your construction is different from those specified, and / or to gain a comprehensive U-value calculation along with a condensation risk analysis of your project, please consult the Kingspan Insulation Technical Service Department for assistance (see rear cover).*

## U-value Table Key

Where an **x** is shown, the U-value is higher than the worst of the maximum new build area weighted average / refurbishment (as applicable) U-values allowed by the 2010 Editions of Approved Documents L to the Building Regulations (England & Wales), the 2010 Editions of Technical Handbooks Section 6 (Scotland), the 2006 Editions of Technical Booklets F (Northern Ireland), or the 2008 Editions of Technical Guidance Documents L\* (Republic of Ireland).

\* Excluding Change of Use and Material Alterations.

## Refurbishment

### 100 mm Brick / 50 mm Cavity / 100 mm Brick Wall

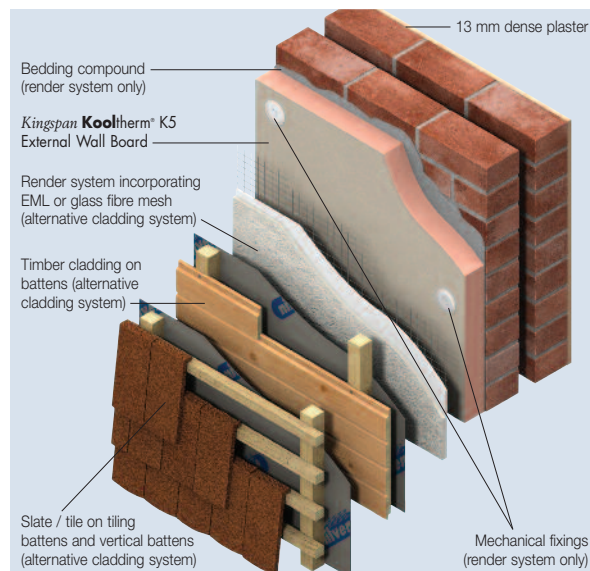

Figure 1

### U-values for Various Thicknesses of Kingspan Kooltherm® K5 External Wall Board with Different Cladding Systems

Insulant Thickness (mm)	U-values (W/m <sup>2</sup> ·K)
<b>10 mm Polymer Render</b>	
50	<b>x</b>
55	0.29
60	0.27
70	0.24
75	0.22
80	0.21
90	0.19
100	0.17
110	0.16
120	0.15
<b>Ventilated Cladding e.g. Timber or Tile Hanging</b>	
50	<b>x</b>
55	0.29
60	0.27
70	0.24
75	0.22
80	0.21
90	0.19
100	0.17
110	0.16
120	0.15

### Solid Brick Wall

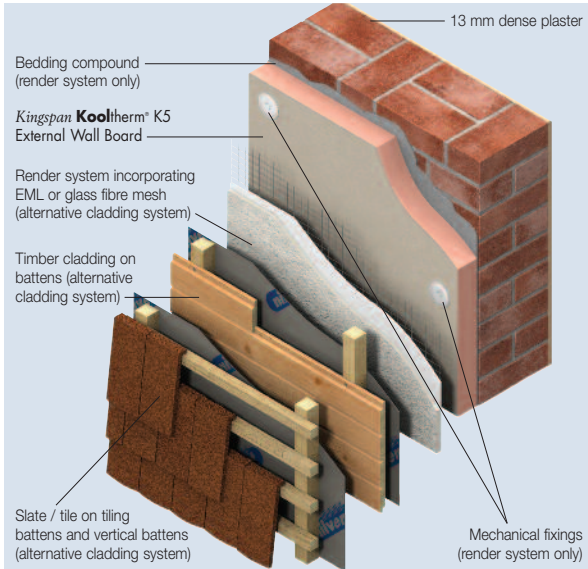

Figure 2

U-values (W/m <sup>2</sup> ·K) for Various Thicknesses of Kingspan Kooltherm® K5 External Wall Board on Different Thicknesses of Brickwork with Different Cladding Systems		
Insulant Thickness (mm)	Brickwork Thickness (mm)	
	102.5	215
<b>10 mm Polymer Render</b>		
50	X	X
55	X	0.30
60	0.29	0.28
70	0.26	0.25
75	0.24	0.23
80	0.23	0.22
90	0.20	0.20
100	0.18	0.18
110	0.17	0.17
120	0.16	0.15
125	0.15	0.15
<b>Ventilated Cladding e.g. Timber or Tile Hanging</b>		
50	X	X
55	X	0.30
60	0.29	0.28
70	0.25	0.25
75	0.24	0.23
80	0.23	0.22
90	0.20	0.20
100	0.18	0.18
110	0.17	0.16
120	0.16	0.15
125	0.15	0.15

### 102.5 mm Brick / 50 mm Cavity / 100 mm Block Wall

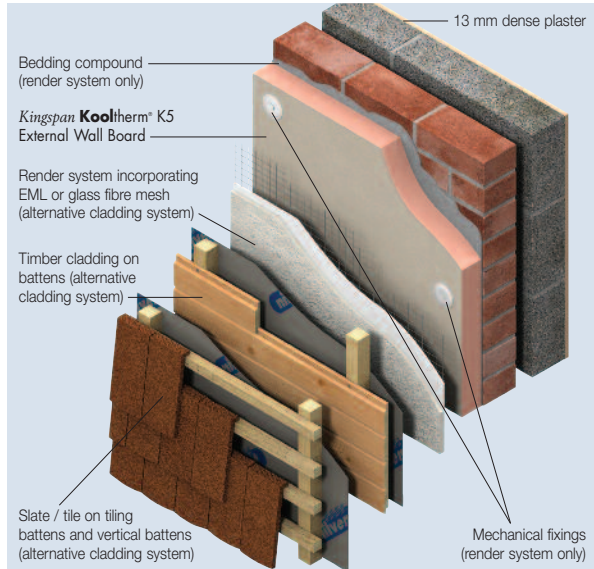

Figure 3

U-values (W/m <sup>2</sup> ·K) for Various Thicknesses of Kingspan Kooltherm® K5 External Wall Board with Different Cladding Systems				
Insulant Thickness (mm)	Inner Leaf Blockwork Density and λ-value (W/m·K)			
	Dense (1.13)	Medium (0.51)	Lightweight (0.15)*	Aerated (0.11)*
<b>10 mm Polymer Render</b>				
40	X	X	X	X
45	X	X	0.29	0.28
50	X	0.30	0.27	0.26
55	0.29	0.28	0.26	0.25
60	0.27	0.26	0.24	0.23
70	0.24	0.23	0.21	0.21
75	0.23	0.22	0.20	0.20
80	0.21	0.21	0.19	0.19
90	0.19	0.19	0.18	0.17
100	0.18	0.17	0.16	0.16
110	0.16	0.16	0.15	0.15
120	0.15	0.15	0.14	0.14
<b>Ventilated Cladding e.g. Timber or Tile Hanging</b>				
40	X	X	X	X
45	X	X	0.29	0.28
50	X	0.30	0.27	0.26
55	0.29	0.28	0.25	0.24
60	0.27	0.26	0.24	0.23
70	0.24	0.23	0.21	0.21
75	0.22	0.22	0.20	0.20
80	0.21	0.21	0.19	0.19
90	0.19	0.19	0.18	0.17
100	0.18	0.17	0.16	0.16
110	0.16	0.16	0.15	0.15
120	0.15	0.15	0.14	0.14

\* A 6.6% thermal bridging factor has assumed for the effect of mortar joints.



# Typical Constructions and U-values

## 100 mm Dense Block\* / 50 mm Cavity / 100 mm Dense Block\* Wall (Original Render Removed)

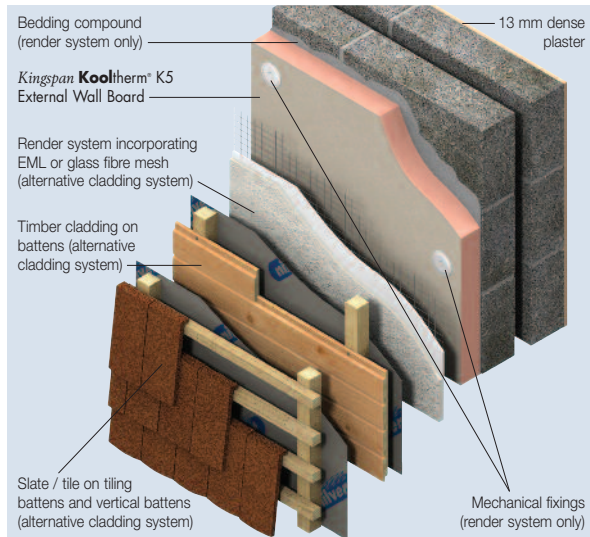

Figure 4

U-values for Various Thicknesses of Kingspan Kooltherm® K5 External Wall Board with Different External Weatherproofing	
Insulant Thickness (mm)	U-values (W/m²·K)
10 mm Polymer Render	
50	X
55	0.29
60	0.27
70	0.24
75	0.23
80	0.22
90	0.19
100	0.18
110	0.16
120	0.15
Ventilated Cladding e.g. Timber or Tile Hanging	
50	X
55	0.29
60	0.27
70	0.24
75	0.23
80	0.21
90	0.19
100	0.18
110	0.16
120	0.15

\* Calculations assume dense block of  $\lambda$ -value 1.13 W/m·K

## New Build

### 215 mm Solid Blockwork Wall

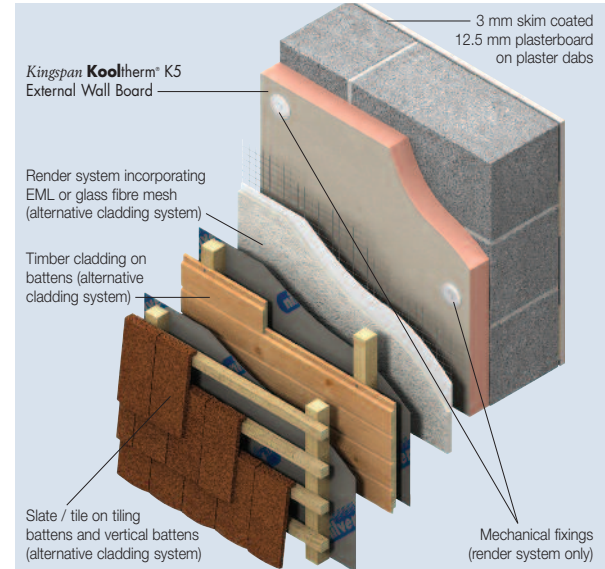

Figure 5

U-values (W/m²·K) for Various Thicknesses of Kingspan Kooltherm® K5 External Wall Board with Different External Weatherproofing						
Insulant Thickness (mm)	Blockwork Density and $\lambda$ -value (W/m·K)					Thin Joint Aerated (0.11)**
	Dense (1.13)	Medium (0.51)	Lightweight (0.15)*	Aerated (0.11)*		
10 mm Polymer Render						
20	X	X	X	0.35	0.34	
25	X	X	0.35	0.31	0.31	
30	X	X	0.32	0.29	0.28	
40	X	X	0.28	0.25	0.25	
45	0.34	0.32	0.26	0.23	0.23	
50	0.32	0.30	0.24	0.22	0.22	
60	0.27	0.26	0.21	0.20	0.20	
70	0.24	0.23	0.19	0.18	0.18	
75	0.23	0.22	0.18	0.17	0.17	
80	0.21	0.21	0.18	0.17	0.16	
90	0.19	0.19	0.16	0.15	0.15	
100	0.18	0.17	0.15	0.14	0.14	
110	0.16	0.16	0.14	0.13	0.13	
120	0.15	0.15	0.13	0.12	0.12	
Ventilated Cladding e.g. Timber or Tile Hanging						
20	X	X	X	0.35	0.34	
25	X	X	0.35	0.31	0.30	
30	X	X	0.32	0.29	0.28	
40	X	X	0.28	0.25	0.25	
45	0.34	0.32	0.25	0.23	0.23	
50	0.32	0.30	0.24	0.22	0.22	
60	0.27	0.26	0.21	0.20	0.20	
70	0.24	0.23	0.19	0.18	0.18	
75	0.23	0.22	0.18	0.17	0.17	
80	0.21	0.20	0.18	0.17	0.16	
90	0.19	0.19	0.16	0.15	0.15	
100	0.18	0.17	0.15	0.14	0.14	
110	0.16	0.16	0.14	0.13	0.13	
120	0.15	0.15	0.13	0.12	0.12	

\* A 6.6% thermal bridging factor has assumed for the effect of mortar joints.

\*\* A 1.4% thermal bridging factor has assumed for the effect of mortar joints.

**100 mm Dense Block\* Outer Leaf / 50 mm Cavity / 100 mm Block Inner Leaf**

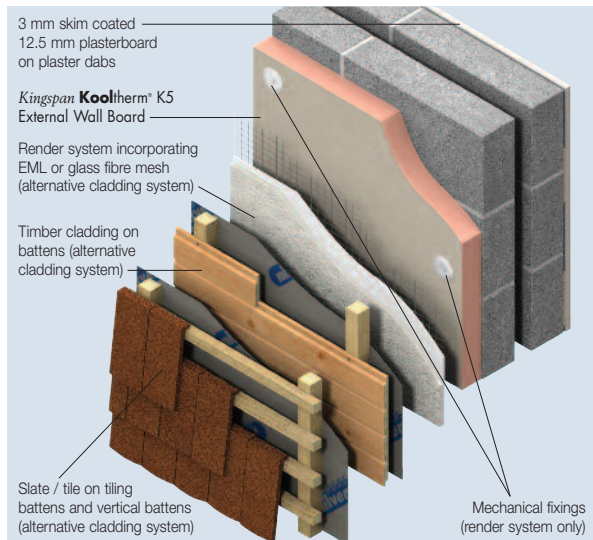

Figure 6

Insulant Thickness (mm)	U-values (W/m <sup>2</sup> ·K) for Various Thicknesses of Kingspan Kooltherm® K5 External Wall Board with Different External Weatherproofing				
	Inner Leaf Blockwork Density and λ-value (W/m·K)				
	Dense (1.13)	Medium (0.51)	Lightweight (0.15)**	Aerated (0.11)**	Thin Joint Aerated (0.11)***
10 mm Polymer Render					
25	X	X	X	X	X
30	X	X	X	0.35	0.34
35	X	X	0.34	0.32	0.32
40	X	0.35	0.31	0.30	0.29
45	0.33	0.31	0.28	0.27	0.27
50	0.30	0.29	0.26	0.25	0.25
60	0.26	0.25	0.23	0.22	0.22
70	0.23	0.23	0.21	0.20	0.20
75	0.22	0.21	0.20	0.19	0.19
80	0.21	0.20	0.19	0.18	0.18
90	0.19	0.18	0.17	0.17	0.17
100	0.17	0.17	0.16	0.15	0.15
110	0.16	0.16	0.15	0.14	0.14
120	0.15	0.14	0.14	0.13	0.13
Ventilated Cladding e.g. Timber or Tile Hanging					
25	X	X	X	X	X
30	X	X	X	0.34	0.34
35	X	X	0.33	0.32	0.31
40	X	0.35	0.31	0.29	0.29
45	0.32	0.31	0.28	0.27	0.27
50	0.30	0.29	0.26	0.25	0.25
60	0.26	0.25	0.23	0.22	0.22
70	0.23	0.22	0.21	0.20	0.20
75	0.22	0.21	0.20	0.19	0.19
80	0.21	0.20	0.19	0.18	0.18
90	0.19	0.18	0.17	0.17	0.17
100	0.17	0.17	0.16	0.15	0.15
110	0.16	0.15	0.15	0.14	0.14
120	0.15	0.14	0.14	0.13	0.13

\* Calculations assume dense block of λ-value 1.13 W/m·K  
 \*\* A 6.6% thermal bridging factor has been assumed for the effect of mortar joints.  
 \*\*\* A 1.4% thermal bridging factor has assumed for the effect of mortar joints.

**Linear Thermal Bridging at Openings**

Linear thermal bridging describes the heat loss at junctions between elements, where the geometry of the junction means that a building's primary insulation layer is not continuous or is reduced. This heat loss is represented by the junction's psi (ψ) value. The ψ-values of all the linear thermal bridges in a building are used in whole building carbon dioxide emissions calculation software.

At a window or door openings, in a wall insulated with Kingspan Kooltherm® K5 External Wall Board, the linear thermal bridge is the reveal.

This linear thermal bridge can be avoided, by positioning the window frame so that its outer face is flush with the outer surface of the masonry wall, and overlapping the window frame with the external wall insulation.

If this is not possible, this linear thermal bridge can be reduced by insulating the reveal. The key factor is the thermal resistance (R-value) of this insulation layer.

Accredited Construction Details (England & Wales / Scotland / Northern Ireland) and Acceptable Construction Details (Republic of Ireland), collectively referred to here as ACDs, feature details for walls with external wall insulation, with reveals insulated with a material of minimum thermal resistance (R-value) of 0.60 m<sup>2</sup>·K/W. These constructions have the following ψ-values: 0.50 W/m·K for a steel lintel with a perforated steel base, 0.30 W/m·K for other lintels (including steel lintels), 0.04 W/m·K for a sill and 0.05 W/m·K for a jamb.

Adhering to these constructions, entitles a designer to use a default ψ-value in whole building carbon dioxide emissions calculation software.

ACDs are specifically targeted at new build constructions but, where applicable, they are also considered best practice for refurbishment.

Reveals should be designed to accommodate the 20 mm of Kingspan Kooltherm® K5 External Wall Board required to achieve an R-value of 0.6 m<sup>2</sup>·K/W, and the depth of the cladding system (see Figure 7).

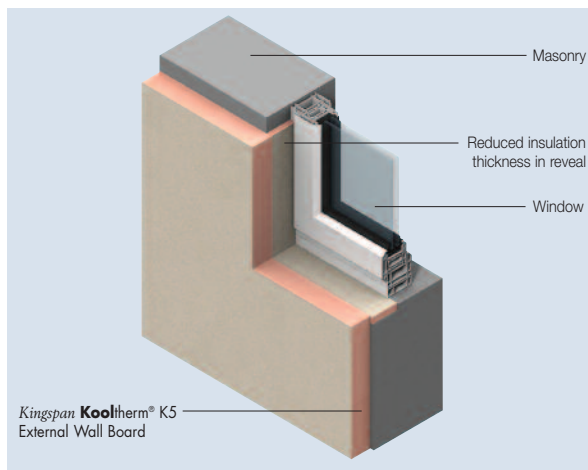

Figure 7

# Design Considerations

## Environmental Impact & Responsible Sourcing

### Green Guide Rating

An Ecoprofile, certified by BRE Certification to the 2008 BRE Environmental Profiles Methodology, has been created for **Kingspan Kooltherm® K5 External Wall Board** produced at Kingspan Insulation's Pembridge manufacturing facility. The BRE has assigned the product a 2008 Green Guide Summary Rating of A+.



Environmental Profiles Scheme  
Certificate Number ENP 410

### Responsible Sourcing

**Kingspan Kooltherm® K5 External Wall Board** produced at Kingspan Insulation's Pembridge and Castleblayney manufacturing facilities is manufactured under a management system certified to BS / I.S. EN ISO 14001: 2004. The principle polymer component of the product produced at these facilities is also manufactured under a management system certified to BS EN ISO 14001: 2004.

*NB The above information is correct at the time of writing. Please confirm at the point of need by contacting Kingspan Insulation's Technical Service Department (see rear cover), from which copies of Kingspan Insulation and its suppliers' ISO 14001 certificates can be obtained along with confirmation of Kingspan Insulation's products' Green Guide ratings.*

## Sustainability & Responsibility

Kingspan Insulation has a long-term commitment to sustainability and responsibility: as a manufacturer and supplier of insulation products; as an employer; as a substantial landholder; and as a key member of its neighbouring communities.

A report covering the sustainability and responsibility of Kingspan Insulation Ltd's British operations is available at [www.kingspaninsulation.co.uk/sustainabilityandresponsibility](http://www.kingspaninsulation.co.uk/sustainabilityandresponsibility).

## Specification Clause

**Kingspan Kooltherm® K5 External Wall Board** should be described in specifications as:-

The external wall insulation shall be **Kingspan Kooltherm® K5 External Wall Board** \_\_\_\_ mm thick: comprising a premium performance rigid thermoset insulation core faced on both sides with a glass tissue based facing. The product shall be manufactured: with a blowing agent that has zero Ozone Depletion Potential (ODP) and low Global Warming Potential (GWP); under a management system certified to BS / I.S. EN ISO 9001: 2008, BS / I.S. EN ISO 14001: 2004 and BS / I.S. OHSAS 18001: 2007; by Kingspan Insulation Limited; and installed in accordance with the instructions issued by them.

## NBS Specifications

Details also available in NBS Plus.

NBS users should refer to clause(s):

M21 210, M21 220, M21 230

(Standard and Intermediate)

M21 20 (Minor Works)



## Water Vapour Control / Condensation

Consideration should be given to the risk of condensation, when designing thermal elements.

A condensation risk analysis should be carried out following the procedures set out in BS 5250: 2002 (Code of practice for the control of condensation in buildings). The Kingspan Insulation Technical Service Department (see rear cover) can provide this service.

## Fire Stops

Current Building Regulations / Standards should be considered with regard to the requirements for, and provision of, fire stops.

# Sitework

## Insulated Render Systems

- Because insulated render systems are proprietary and utilise different mechanisms for attaching insulation to the wall structure, sitework guidance should be sought from the render system manufacturer. However, in the absence of any other guidance, the instructions laid out below may be followed.
  - The external masonry wall should be clean, flat, and free from protrusions.
  - Where an uneven surface remains, it is recommended that a bedding compound can be applied prior to fixing the insulation boards.
  - External wall insulation should start 150 / 200 / 600\* mm below the top surface of the ground floor insulation / perimeter insulation upstand (whichever is higher) for a concrete floor, or 200 mm below the top surface of the ground floor insulation / perimeter insulation upstand (whichever is higher) for a suspended timber floor.
- \* 150 mm applies to the UK. 200 mm applies to the Republic of Ireland if a row of insulating blockwork (thermal conductivity < 0.20 W/m·K) is used, otherwise 600 mm applies.
- Insulation boards should be installed break-bonded, with joints lightly butted.
  - Care should be taken to install the specified thickness of insulation around reveals (see Figure 7).
  - Boards of **Kingspan Kooltherm® K5 External Wall Board** are mechanically fixed to the exterior of masonry external walls, preferably using thermally broken telescopic tube fasteners.
  - A minimum of 5 fixings are required to secure an insulation board to the masonry wall.
  - Board edges at openings and external corners should be fixed with fasteners at minimum 300 mm centres.
  - Fasteners at board edges must be located > 50 mm, and < 150 mm, from edges and corners of the board, and not overlap board joints.
  - The requirement for additional fixings is dependent on the render system being applied and the type of fixing being used.

For details on fixings refer to:

Ejot UK Limited	+44 (0) 1977 687 040
<a href="http://www.ejot.co.uk">www.ejot.co.uk</a>	
Helifix Limited	+44 (0) 20 8735 5222
<a href="http://www.helifix.co.uk">www.helifix.co.uk</a>	
MAK Fasteners	+353 (0) 1 451 99 00
<a href="http://www.makfasteners.com">www.makfasteners.com</a>	
SFS Intec	+44 (0) 113 2085 500
<a href="http://www.sfsintec.biz/uk">www.sfsintec.biz/uk</a>	
Tech Fasteners	+353 (0) 1 457 33 00
<a href="http://www.techfasteners.ie">www.techfasteners.ie</a>	
Wallfast Limited	+44 (0) 23 928443
<a href="http://www.wallfast.co.uk">www.wallfast.co.uk</a>	

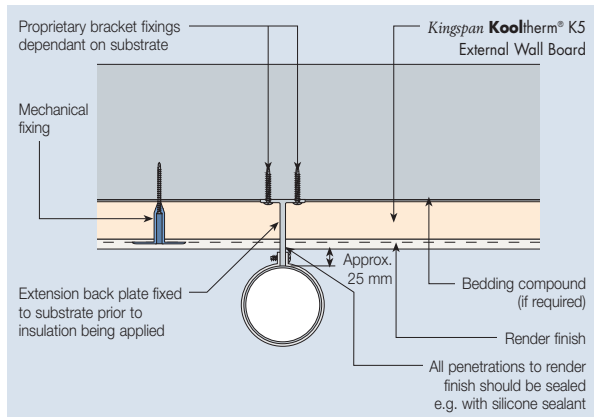

Figure 8 – Drainpipe Extension Detail (Applicable to a Variety of External Building Ancillaries)

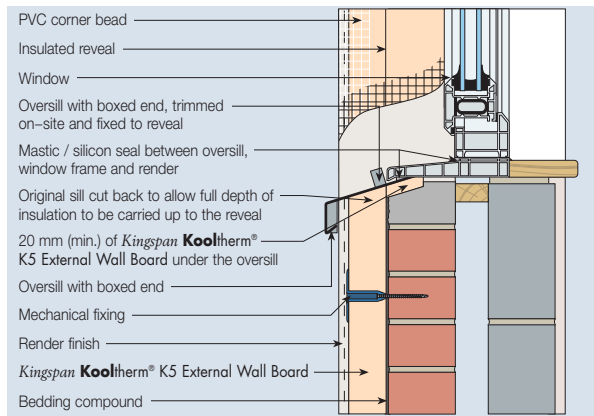

Figure 9 – Oversill Extension Detail (Refurbishment)

- Wherever possible, care should be taken to avoid cold bridging when attaching services and ancillaries to the exterior of the building (see Figure 8).
- Depending on the render finish being applied, advice must be sought from the render manufacturer on the EML / glass fibre mesh and bedding mortar to be applied.
- In refurbishment projects, sill extenders and flashings should be used around openings, with care taken to avoid cold bridging (see Figure 9).

# Sitework

## Ventilated Cladding Systems

- Boards of *Kingspan Kooltherm*® K5 External Wall Board should be temporarily fastened to the external masonry wall using mechanical fixings or a bedding compound.
- External wall insulation should start 150 / 200 / 600\* mm below the top surface of the ground floor insulation / perimeter insulation upstand (whichever is higher) for a concrete floor, or 200 mm below the top surface of the ground floor insulation / perimeter insulation upstand (whichever is higher) for a suspended timber floor.

\* 150 mm applies to the UK. 200 mm applies to the Republic of Ireland if a row of insulating blockwork (thermal conductivity < 0.20 W/m·K) is used, otherwise 600 mm applies.

- Insulation boards should be installed break-bonded, with joints lightly butted.
- Care should be taken to install the specified thickness of insulation around reveals (see Figure 7).
- A breathable membrane, e.g. *Kingspan nilvent*®, is installed over the insulation and temporarily stapled or pinned in place.
- Minimum 38 mm x 38 mm vertical treated softwood timber battens are fixed, through the breathable membrane and insulation, to the masonry wall.
- When selecting the type of fixing and fixing frequency for the vertical battens, consideration must be given to the weight of cladding to be fixed to them, the design of the wall, and wind loading.
- For details on fixings refer to the list on the previous page.
- If the cladding system is to be tile / slate hanging, horizontal tiling battens can then be fixed to the vertical battens.
- Horizontal tiling battens and the tile / slate cladding that is to be fixed to them should be installed in accordance with the tile / slate cladding manufacturers recommendations.
- Alternatively, timber cladding can be fixed directly to the vertical battens.
- If the cladding system is to be finished with render, the render carrier (e.g. calcium silicate board, expanded metal lath) can be fixed directly to the vertical battens.
- The dry cladding system should be secured in accordance with the manufacturer's recommendations.
- Wherever possible, care should be taken to avoid cold bridging when attaching services and ancillaries to the exterior of the building.
- In refurbishment projects, sill extenders and flashings should be used around openings, with care taken to avoid cold bridging.

## General

### Cutting

- Cutting should be carried out either by using a fine toothed saw, or by scoring with a sharp knife, snapping the board over a straight edge and then cutting the facing on the other side.
- Ensure accurate trimming to achieve close-butting joints and continuity of insulation.

### Daily Working Practice

- At the completion of each day's work, or whenever work is interrupted for extended periods of time, board edges and joints should be protected from inclement weather.

### Availability

- *Kingspan Kooltherm*® K5 External Wall Board is available through specialist insulation distributors and selected builders' merchants throughout the UK and Ireland.

### Packaging and Storage

- The polyethylene packaging of Kingspan Insulation products, which is recyclable, should not be considered adequate for outdoor protection.
- Ideally, boards should be stored inside a building. If, however, outside storage cannot be avoided, then the boards should be stacked clear of the ground and covered with an opaque polythene sheet or weatherproof tarpaulin. Boards that have been allowed to get wet should not be used.

### Health and Safety

- Kingspan Insulation products are chemically inert and safe to use.
- A Safety Information Data Sheet for this product is available from the Kingspan Insulation website [www.kingspaninsulation.co.uk/safety](http://www.kingspaninsulation.co.uk/safety) or [www.kingspaninsulation.ie/safety](http://www.kingspaninsulation.ie/safety).

Warning – do not stand on or otherwise support your weight on this product unless it is fully supported by a load bearing surface.



# Product Details

## The Facings

*Kingspan Kooltherm*® K5 External Wall Board is faced on both sides with a glass tissue based facing, autohesively bonded to the insulation core during manufacture.

## The Core

The core of *Kingspan Kooltherm*® K5 External Wall Board is a premium performance rigid thermoset modified resin insulant manufactured with a blowing agent that has zero Ozone Depletion Potential (ODP) and low Global Warming Potential (GWP).



## Standards and Approvals

*Kingspan Kooltherm*® K5 External Wall Board is manufactured to the highest standards under a management system certified to BS / I.S. EN ISO 9001: 2008 (Quality management systems. Requirements), BS / I.S. EN ISO 14001 : 2004 (Environmental Management Systems. Requirements) and BS / I.S OHSAS 18001: 2007 (Health and Safety Management Systems. Requirements).

*Kingspan Kooltherm*® K5 External Wall Board is used as an integral component of several BBA / NSAI Agrément Certified rendered external wall insulation systems. For further details of BBA / NSAI Agrément Certification please contact the Kingspan Insulation Technical Service Department (see rear cover).

## Standard Dimensions

*Kingspan Kooltherm*® K5 External Wall Board is available in the following standard size:

Nominal Dimension		Availability
Length	(m)	1.2
Width	(m)	0.6
Insulant Thickness	(mm)	Refer to local distributor or Kingspan Insulation price list for current stock and non-stock sizes.

## Compressive Strength

The compressive strength of *Kingspan Kooltherm*® K5 External Wall Board typically exceeds 120 kPa at 10% compression, when tested to BS / I.S.EN 826: 1996 (Thermal insulating products for building applications. Determination of compression behaviour).

## Water Vapour Resistivity

The product typically achieves a resistivity greater than 300 MN·s/g·m, when tested in accordance with BS EN 12086: 1997 / I.S. EN 12086: 1998 (Thermal insulating products for building applications Determination of water vapour transmission properties).

## Durability

If correctly installed, *Kingspan Kooltherm*® K5 External Wall Board can have an indefinite life. Its durability depends on the supporting structure and the conditions of its use.

## Resistance to Solvents, Fungi & Rodents

The insulation core is resistant to short-term contact with petrol and with most dilute acids, alkalis and mineral oils. However, it is recommended that any spills be cleaned off fully before the boards are installed. Ensure that safe methods of cleaning are used, as recommended by suppliers of the spilt liquid. The insulation core is not resistant to some solvent-based adhesive systems, particularly those containing methyl ethyl ketone. Adhesives containing such solvents should not be used in association with this product. Damaged boards or boards that have been in contact with harsh solvents or acids should not be used.

The insulation core and facings used in the manufacture of *Kingspan Kooltherm*® K5 External Wall Board resist attack by mould and microbial growth and do not provide any food value to vermin.

# Product Details

## Fire Performance

*Kingspan Kooltherm*<sup>®</sup> K5 External Wall Board, and its rigid thermoset insulation core, are Class 0, as defined by the Building Regulations.

The rigid thermoset insulation core of *Kingspan Kooltherm*<sup>®</sup> K5 External Wall Board, when subjected to the British Standard fire test specified in the table below, has achieved the result shown.

Test	Result
BS 5111-1: 1974 (Smoke Obscuration)	< 5% (Negligible smoke obscuration)

Further details of the fire performance of Kingspan Insulation products may be obtained from the Kingspan Insulation Technical Service Department (see rear cover).

## Thermal Properties

The  $\lambda$ -values and R-values detailed below are quoted in accordance with BS / I.S. EN 13166: 2008 (Thermal insulation products for buildings – Factory made products of phenolic foam (PF) – Specification).

### Thermal Conductivity

The boards achieve a thermal conductivity ( $\lambda$ -value) of: 0.023 W/m·K (insulant thickness 15–24 mm); 0.021 W/m·K (insulant thickness 25–44 mm); and 0.020 W/m·K (insulant thickness  $\geq$  45 mm).

### Thermal Resistance

Thermal resistance (R-value) varies with thickness and is calculated by dividing the thickness of the board (expressed in metres) by its thermal conductivity. The resulting number is rounded down to the nearest 0.05 (m<sup>2</sup>·K/W).

Insulant Thickness (mm)	Thermal Resistance (m <sup>2</sup> ·K/W)
20	0.85
25	1.15
30	1.40
35	1.65
40	1.90
45	2.25
50	2.50
55	2.75
60	3.00
70	3.50
75	3.75
80	4.00
90	4.50
100	5.00
110	5.50
120	6.00
125	6.25

Refer to local distributor or Kingspan Insulation price list for current stock and non-stock sizes.

# Kingspan Insulation

## Company Details

Kingspan Insulation Ltd is part of the Kingspan Group plc., one of Europe's leading construction product manufacturers. The Kingspan Group was formed in the late 1960s and is a publicly quoted group of companies headquartered in Kingscourt, County Cavan, Ireland.

Kingspan Insulation Ltd is a market leading manufacturer of premium and high performance rigid insulation products and insulated systems for building fabric and building services applications.

## Products & Applications

Kingspan Insulation Ltd has a vast product range. Kingspan Insulation Ltd products are suitable for both new build and refurbishment in a variety of applications within both domestic and non-domestic buildings.

### Insulation for:

- Pitched Roofs
- Flat Roofs
- Green Roofs
- Cavity Walls
- Solid Walls
- Timber and Steel Framing
- Insulated Cladding Systems
- Insulated Render Systems
- Floors
- Soffits
- Ductwork

### Further Solutions:

- Insulated Dry-Lining
- Tapered Roofing Systems
- Cavity Closers
- **Kingspan KoolDuct**® Pre-Insulated Ducting
- **Kingspan nilventi**® Breathable Membranes
- **Kingspan TEK**® Building System

## Insulation Product Benefits

### **Kingspan Kooltherm**® K-range Products

- With a thermal conductivity of 0.020–0.023 W/m·K these are the most thermally efficient insulation products commonly used.
- The thinnest commonly used insulation products for any specific U-value.
- Rigid thermoset insulation core is Class 0, as defined by the Building Regulations in England, Wales & Ireland, and Low Risk, as defined by the Building Standards in Scotland.
- Rigid thermoset insulation core achieves the best possible rating of < 5% smoke obscuration when tested to BS 5111: Part 1: 1974.
- Manufactured with a blowing agent that has zero Ozone Depletion Potential (ODP) and low Global Warming Potential (GWP).

### **Kingspan Therma**™ Range Products

- With a thermal conductivity of 0.022–0.027 W/m·K these are amongst the more thermally efficient insulation products commonly used.
- Each product achieves the required fire performance for its intended application.
- Manufactured with a blowing agent that has zero Ozone Depletion Potential (ODP) and low Global Warming Potential (GWP).

### **Kingspan Styrozone**® Range Products

- Rigid extruded polystyrene insulation (XPS) has the necessary compressive strength to make it the product of choice for specialist applications such as heavy duty flooring, car park decks and inverted roofing.
- Each product achieves the required fire performance for its intended application.
- Manufactured with a blowing agent that has zero Ozone Depletion Potential (ODP).

### **All Products**

- Their closed cell structure resists both moisture and water vapour ingress – a problem which can be associated with open cell materials such as mineral fibre and which can result in reduced thermal performance.
- Unaffected by air infiltration – a problem that can be experienced with mineral fibre and which can reduce thermal performance.
- Safe and easy to install – non-fibrous.
- If installed correctly, can provide reliable long term thermal performance over the lifetime of the building.

# Contact Details

## Customer Service

For quotations, order placement and details of despatches please contact the Kingspan Insulation Customer Service Department on the numbers below:

UK	- Tel:	+44 (0) 1544 388 601
	- Fax:	+44 (0) 1544 388 888
	- email:	customerservice@kingspaninsulation.co.uk
Ireland	- Tel:	+353 (0) 42 979 5000
	- Fax:	+353 (0) 42 975 4299
	- email:	info@kingspaninsulation.ie

## Literature & Samples

Kingspan Insulation produces a comprehensive range of technical literature for specifiers, contractors, stockists and end users. The literature contains clear 'user friendly' advice on typical design; design considerations; thermal properties; sitework and product data.

Available as a complete Design Manual or as individual product brochures, Kingspan Insulation technical literature is an essential specification tool. For copies please contact the Kingspan Insulation Marketing Department, or visit the Kingspan Insulation website, using the details below:

UK	- Tel:	+44 (0) 1544 387 384
	- Fax:	+44 (0) 1544 387 484
	- email:	literature@kingspaninsulation.co.uk
	- www.kingspaninsulation.co.uk/literature	
Ireland	- Tel:	+353 (0) 42 979 5000
	- Fax:	+353 (0) 42 975 4299
	- email:	info@kingspaninsulation.ie
	- www.kingspaninsulation.ie/literature	

## Tapered Roofing

For technical guidance, quotations, order placement and details of despatches please contact the Kingspan Insulation Tapered Roofing Department on the numbers below:

UK	- Tel:	+44 (0) 1544 387 383
	- Fax:	+44 (0) 1544 387 483
	- email:	tapered@kingspaninsulation.co.uk
Ireland	- Tel:	+353 (0) 42 975 4297
	- Fax:	+353 (0) 42 975 4296
	- email:	tapered@kingspaninsulation.ie

## Technical Advice / Design

Kingspan Insulation supports all of its products with a comprehensive Technical Advisory Service for specifiers, stockists and contractors.

This includes a computer-aided service designed to give fast, accurate technical advice. Simply phone the Kingspan Insulation Technical Service Department with your project specification. Calculations can be carried out to provide U-values, condensation / dew point risk, required insulation thicknesses etc... Thereafter any number of permutations can be provided to help you achieve your desired targets.

The Kingspan Insulation Technical Service Department can also give general application advice and advice on design detailing and fixing etc... Site surveys are also undertaken as appropriate.

The Kingspan Insulation British Technical Service Department operates under a management system certified to the BBA Scheme for Assessing the Competency of Persons to Undertake U-value and Condensation Risk Calculations.



Please contact the Kingspan Insulation Technical Service Department on the numbers below:

UK	- Tel:	+44 (0) 1544 387 382
	- Fax:	+44 (0) 1544 387 482
	- email:	technical@kingspaninsulation.co.uk
Ireland	- Tel:	+353 (0) 42 975 4297
	- Fax:	+353 (0) 42 975 4296
	- email:	technical@kingspaninsulation.ie

## General Enquiries

For all other enquiries contact Kingspan Insulation on the numbers below:

UK	- Tel:	+44 (0) 1544 388 601
	- Fax:	+44 (0) 1544 388 888
	- email:	info@kingspaninsulation.co.uk
Ireland	- Tel:	+353 (0) 42 979 5000
	- Fax:	+353 (0) 42 975 4296
	- email:	info@kingspaninsulation.ie

*Kingspan Insulation Ltd. reserves the right to amend product specifications without prior notice. Product thicknesses shown in this document should not be taken as being available ex-stock and reference should be made to the current Kingspan Insulation price-list or advice sought from Kingspan Insulation's Customer Service Department (see above left). The information, technical details and fixing instructions etc. included in this literature are given in good faith and apply to uses described. Recommendations for use should be verified for suitability and compliance with actual requirements, specifications and any applicable laws and regulations. For other applications or conditions of use, Kingspan Insulation offers a Technical Advisory Service (see above), the advice of which should be sought for uses of Kingspan Insulation products that are not specifically described herein. Please check that your copy of this literature is current by contacting the Kingspan Insulation Marketing Department (see left).*

Kingspan Insulation Ltd is a member of:

The Insulated Render and Cladding Association (INCA)  
The National Insulation Association (NIA)



**Kingspan Insulation Ltd**

Pembridge, Leominster, Herefordshire HR6 9LA, UK  
Castleblayney, County Monaghan, Ireland

[www.kingspaninsulation.co.uk](http://www.kingspaninsulation.co.uk) [www.kingspaninsulation.ie](http://www.kingspaninsulation.ie)